

Adwa

USER MANUAL

AD110 and AD111 pH/°C and pH/mV/°C Meters



www.adwainstruments.com



IRSANAT.com

فروشگاه ایران صنعت

Dear Customer,

Thank you for choosing an Adwa product.

Please read carefully this manual before starting operations.

This instrument is in compliance with the EMC Directive 89/336/EEC and Low Voltage Directive 73/23/EEC for electrical equipments.

For additional technical information, please e-mail us at **sales@adwainstruments.com**.

TABLE OF CONTENTS

Introduction	5
Technical Data	6
Display and Keyboard Functions	7
Measurements	9
Calibration	12
Battery Replacement	15
Electrode Maintenance	16
Probes and Solutions	17
Notes	19

INTRODUCTION

AD110 and **AD111** are compact pH meters featuring automatic pH calibration, hold function, low battery indication, temperature measurement and compensation. In addition, **AD111** can measure in the mV range, if using proper electrode.

Both models are supplied complete with:

- **AD1230B** pH electrode with Epoxy body, tip protection bottle, BNC connector and 1 m cable
- **AD7662** stainless steel temperature probe, 1 m cable
- pH 4.01 and pH 7.01 calibration buffers (20 ml sachet each)
- Batteries (4 x 1.5V AA alkaline)
- Instruction manual

TECHNICAL DATA

	AD110	AD111
Range	-2.00 to 16.00 pH / -5.0 to 105.0 °C ---	±1000 mV
Resolution	0.01 pH / 0.1 °C ---	1 mV
Accuracy@25°C	±0.02 pH ±0.5 °C up to 60 °C / ±1 °C outside ---	±2 mV
pH Calibration	Automatic, 1 or 2 point, with 3 memorized buffer values (pH 4.01, 7.01 and 10.01)	
mV Calibration	---	Factory
Temp. Calibration	Factory	
Temp. Compensation	Automatic or 25 °C fixed	
Battery Type / Life	4 x 1.5V AA / approx. 1500 hours of use	
Auto-off	After 8 minutes of non-use	
Environment	0 to 50 °C; RH max 95%	
Dimensions	70 x 145 x 26 mm	
Weight	Approx. 200 g	

DISPLAY AND KEYBOARD FUNCTIONS

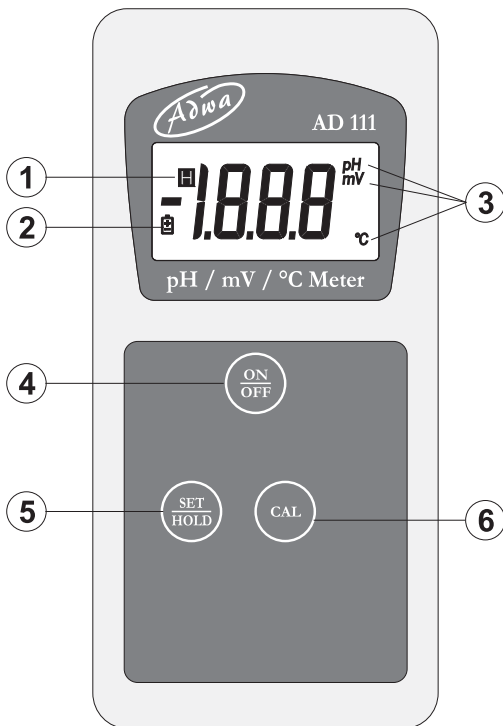

Display

1. **H symbol**, lights up to indicate that the reading is frozen on display
2. **Battery symbol**, lights up to indicate a low battery condition
3. **Measure unit** of the displayed reading: pH, mV (AD111 only) or °C

Keyboard

4. **ON/OFF** key, to turn the instrument ON and OFF
5. **SET/HOLD** key, to select measurement range, confirm calibration points, and freeze reading on display (keep pressed)
6. **CAL** key, to enter/exit calibration mode

MEASUREMENTS

- Each instrument is supplied complete with four 1.5V batteries. Install the batteries as explained in the “Battery Replacement” paragraph (see page 14).
- Attach pH electrode and temperature probe to the connectors on the top of the instrument.

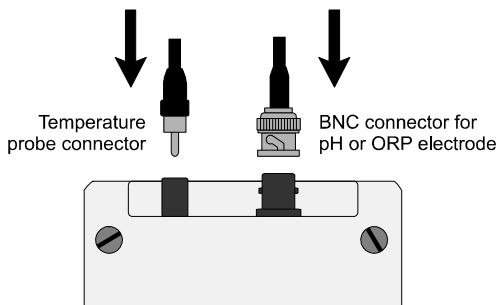

- Turn ON by pressing the ON/OFF key.
- Remove the protective bottle from the pH electrode tip. Immerse pH electrode and temperature probe in the solution to be tested, stir gently and wait for stable reading.

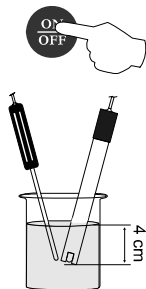

Note: The pH electrode tip should be submersed at least 4 cm into the solution.

Note: The temperature probe should be located as near as possible to the pH electrode.

- Press the SET/HOLD key to display the desired range: pH, mV (only for **AD111** with the proper electrode), or °C (temperature).



pH readings are automatically compensated for temperature variations.

- If the temperature probe is not connected, the compensation is done at a fixed value of 25 °C (the “°C” tag blinks to advise the operator).



- To freeze the display, from measurement mode, press and hold the SET/HOLD key until the “H” tag lights up.



Press SET/HOLD again to return to normal mode.

- After use, turn the meter OFF by pressing ON/OFF and disconnect the probes.

- Clean the pH electrode with water and insert the tip protection bottle. Never let the electrode tip dry. See “Electrode Maintenance” paragraph (page 15) for details.

CALIBRATION

The instrument is **factory calibrated for mV and temperature ranges**. Contact your dealer for re-calibration, if necessary.

For **pH calibration**, proceed as follows:

- Enter the calibration mode by pressing CAL key. “7.01 pH” will start blinking.

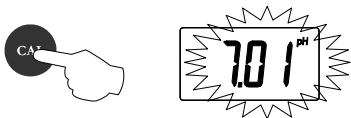

- For a *single-point calibration*, immerse pH electrode and temperature probe in any of the memorized buffers (e.g. pH 4.01, 7.01 or 10.01).



- The meter automatically recognizes and displays the buffer value.



- When the pH tag stops blinking, press SET/HOLD to confirm the calibration point.



Note: If the pH 7.01 buffer was used, press SET/HOLD again to exit the calibration mode. Otherwise, if a different buffer was used, the meter automatically returns to normal mode.

- For a *two-point calibration*, immerse pH electrode and temperature probe in pH 7.01 buffer.



- The meter automatically recognizes and displays the buffer value.

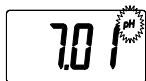

- When the pH tag stops blinking, press SET/HOLD to confirm and store the first calibration point.



- The meter will then ask for the second buffer.



- Immerse pH electrode and temperature probe in pH 4.01 (or pH 10.01) buffer.



- When also this buffer is recognized, press SET/HOLD to confirm and store the second calibration point; the meter will return to normal mode.



Note: If a solution with wrong pH value is used as buffer for calibration, the LCD displays the “Ec” message.

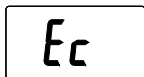

Note: *To exit the calibration mode*, press CAL at any time. The meter will display dashes and then return to normal measurement mode.



Note: *To reset to the default values*, after entering the calibration mode and before the first point is confirmed (pH tag is blinking), press and hold the SET/HOLD key, and then CAL.



Note: For better accuracy it is recommended to carry out a 2-point calibration procedure.

BATTERY REPLACEMENT

When the batteries become weak, the battery symbol on the LCD lights up.



When the low battery indicator appears only a few hours of battery life is remaining. It is recommended to replace the batteries immediately.

In addition, when the battery level is too low to ensure reliable readings, the Battery Error Prevention System (BEPS) warns the user by displaying the "Eb" message and then switches the instrument off.

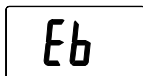

To replace the batteries remove the battery compartment cover on the rear of the instrument and replace all four 1.5V AA batteries while paying attention to their polarity.

Batteries should only be replaced in a safe area and using the battery type specified in this instruction manual.

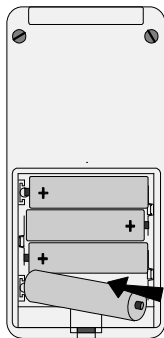

ELECTRODE MAINTENANCE

Storage

To minimize clogging and ensure a quick response time, the glass bulb and the junction of the pH electrode should always be kept moist.

When not in use, store the electrode with the tip protective bottle. If you need to add some solution to the tip protective bottle, use the **AD70300** storage solution.

Periodic Maintenance

Inspect electrode and cable. The cable used for the connection to the instrument must be intact and there must be no points of broken insulation on the cable or cracks on the electrode stem or bulb. If any scratches or cracks are present, replace the electrode.

Rinse off any salt deposits with water.

Connectors must be perfectly clean and dry.

Cleaning Procedure

Soak in deionized water for approximately 30 minutes, then rinse the electrode thoroughly with deionized water and soak it in **AD7061** cleaning solution for at least 1 hour before taking measurements.

PROBES AND SOLUTIONS

AD1230B	pH electrode with Epoxy body, tip protection bottle, BNC connector and 1 m cable
AD3230B	ORP electrode with Epoxy body, tip protection bottle, BNC connector and 1 m cable
AD7662	Stainless steel temperature probe with 1 m cable
AD70004P	pH 4.01 buffer solution, 20 ml sachet, 25 pcs.
AD70007P	pH 7.01 buffer solution, 20 ml sachet, 25 pcs.
AD70010P	pH 10.01 buffer solution, 20 ml sachet, 25 pcs.
AD70300	Storage solution, 230 ml
AD7061	Cleaning solution, 230 ml

NOTES



IRSANAT .com

فروشگاه ايران صنعت

ADWA INSTRUMENTS Kft.

Alsókikötő sor 11, 6726 Szeged, Hungary

Tel. +36 62 317 878

Fax +36 62 550 610

e-mail: sales@adwainstruments.com

www.adwainstruments.com